

**iQ parts**  
IQ-PARTS-SHOP.COM

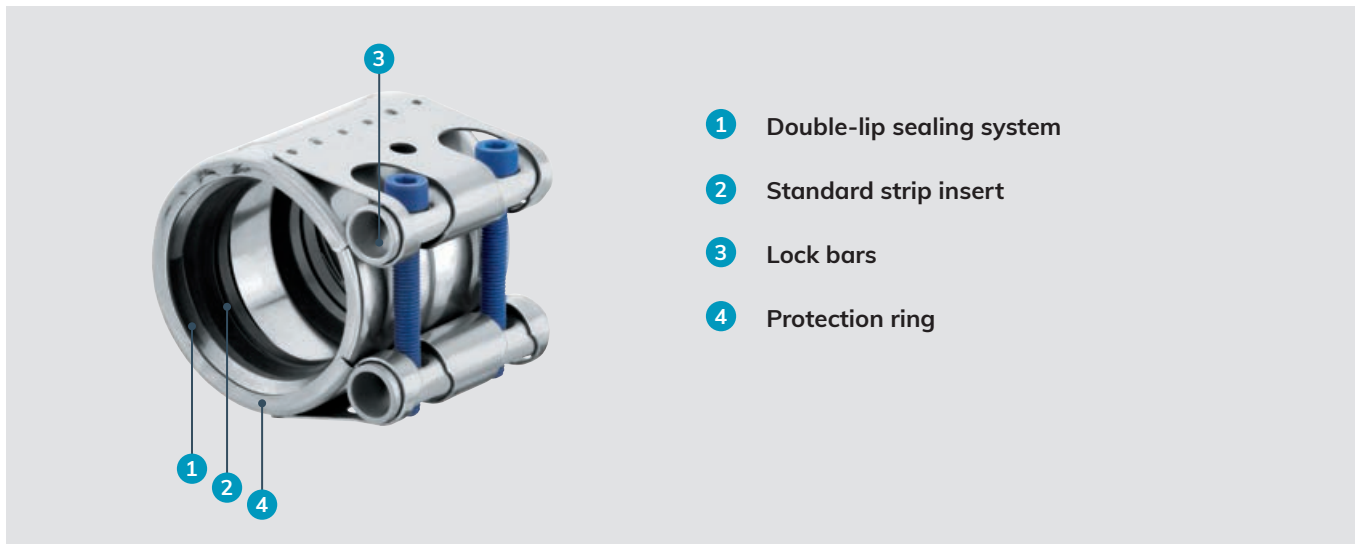

**SPECS &  
INFORMATION**



- 1 Double-lip sealing system
- 2 Standard strip insert
- 3 Lock bars
- 4 Protection ring

## The protective pipe coupling

NORMACONNECT® FLEX /FLEX E are axial non-restraint couplings. They are used for all kind of metal pipes, as well as pipes made of concrete or plastic. Sealing reliability is ensured even when NORMACONNECT® FLEX /FLEX E pipe couplings are mounted on pipes with or without a gap and also on compensated pipes.



NORMACONNECT®

### Advantages at a glance

- ✓ Compensates for thermal elongation of the pipes
- ✓ Joining all kind of pipe materials is possible, e.g., for steel, plastic, cast iron, etc.

### Information

- Sizes: 26.9 mm –1219.1 mm
- Working pressure: 70.0 – 4.0 bar
- Material: AISI 304, AISI 316 Ti
- EPDM:
  - Sizes from 26.9 mm up to 168.3 mm: -30 °C up to +125 °C
  - Sizes > 180.0 mm: -20 °C up to +80 °C
- NBR: from -20 °C up to +80 °C
- FKM: -10 °C to +150 °C  
(Higher temperatures possible in some cases.)



### Materials

W1	W2	W3	W4	W5
	x		x	x

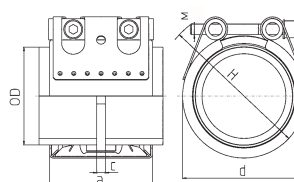
### Technical data & Ordering information



Technical data & Ordering information

NORMACONNECT® FGR FLEX E											
Ø (O.D.)	Designation	Clamping ranges Oadmin - Odmax (mm)	PN <sup>1</sup> (MAWP <sup>1</sup> from diameter 180)	WP <sup>2</sup>	C max	Dimensions (approx.)			Weight (approx.) (kg/pc.)	Hex socket locking bolts	
			 [bar]	 [bar]	(mm)	a (mm)	d (mm)	H (mm)		Thread	Tightening torque (Nm)
26.9	Flex E 26.9	26.4-27.5	16	70	3	67	50	70	0.31	M 8 SW 6	5
28.0	Flex E 28.0	27.5-28.5	16	70	3	67	50	70	0.31	M 8 SW 6	5
30.0	Flex E 30.0	29.5-30.6	16	70	3	67	50	70	0.31	M 8 SW 6	5
33.7	Flex E 33.7	33.0-34.3	16	60	3	67	55	75	0.32	M 8 SW 6	5
35.0	Flex E 35.0	34.5-35.6	16	60	8	63	55	75	0.43	M 8 SW 6	5
38.0	Flex E 38.0	37.5-38.6	16	60	8	63	60	80	0.43	M 8 SW 6	5
42.4	Flex E 42.4	41.7-43.0	16	50	8	63	65	85	0.44	M 8 SW 6	5
44.5	Flex E 44.5	44.0-45.1	16	50	8	63	65	85	0.45	M 8 SW 6	5
48.3	Flex E 48.3	47.6-50.5	16	50	8	63	70	90	0.46	M 8 SW 6	5
54.0	Flex E 54.0	53.3-54.6	16	50	17	78	75	95	0.60	M 8 SW 6	10
57.0	Flex E 57.0	56.3-57.7	16	50	17	78	80	100	0.61	M 8 SW 6	10
60.3	Flex E 60.3	59.5-61.0	16	40	17	78	85	105	0.62	M 8 SW 6	10
63.0	FLEX E 63.0	62.2-63.9	16	40	17	78	85	105	0.62	M 8 SW 6	10
70.0	Flex E 70.0	69.0-71.0	16	40	25	98	90	110	1.16	M 8 SW 6	10
73.0	Flex E 73.0	72.1-73.8	16	40	25	98	95	115	1.18	M 8 SW 6	10
76.1	Flex E 76.1	75.2-77.0	16	35	25	98	100	120	1.18	M 8 SW 6	10
80.0	Flex E 80.0	79.0-80.8	16	35	25	98	100	120	1.21	M 8 SW 6	10
84.0	Flex E 84.0	83.0-85.0	16	35	25	98	105	125	1.24	M 8 SW 6	10
88.9	Flex E 88.9	87.0-89.9	16	35	25	98	110	130	1.26	M 8 SW 6	10
101.6	Flex E 101.6	100.4-102.8	16	35	25	98	125	145	1.39	M 8 SW 6	10
104.0	Flex E 104.0	102.8-106.1	16	35	25	98	125	145	1.40	M 8 SW 6	10
108.0	Flex E 108.0	106.8-109.2	16	35	25	98	130	150	1.42	M 8 SW 6	10
110.0	Flex E 110.0	108.8-111.4	16	35	25	98	130	150	1.47	M 8 SW 6	10
114.3	Flex E 114.3	113.0-115.5	16	35	25	98	135	155	1.47	M 8 SW 6	15
129.0	Flex E 129.0	127.6-131.1	16	32	35	113	155	185	2.10	M 10 SW 8	20
133.0	Flex E 133.0	131.5-134.4	16	32	35	113	160	190	2.13	M 10 SW 8	20
139.7	Flex E 139.7	138.1-141.6	16	32	35	113	165	195	2.19	M 10 SW 8	25
141.3	Flex E 141.3	139.6-142.8	16	32	35	113	170	200	2.19	M 10 SW 8	25
154.0	Flex E 154.0	152.3-156.1	16	32	35	113	180	210	2.31	M 10 SW 8	30
159.0	Flex E 159.0	157.3-160.7	16	32	35	113	185	215	2.38	M 10 SW 8	30
168.3	Flex E 168.3	166.5-170.1	16	32	35	113	195	225	2.43	M 10 SW 8	30

PN<sup>1</sup> (Nominal Pressure) is the max. admissible working pressure in shipbuilding, based on a safety factor of ≥ 4.  
 MAWP<sup>1</sup> (Maximum Allowable Working Pressure) is the max. admissible working pressure in shipbuilding, based on a safety factor of ≥ 4.  
 WP<sup>2</sup> is the max. working pressure in industrial applications, with a safety factor as per NORMA specification.

NORMACONNECT®

## Technical data &amp; Ordering information



NORMACONNECT® FGR FLEX E								
Ø (O.D.)	Designation	W2 Product No.		W4 Product No.		W5 Product No.		
		EPDM	NBR	EPDM	NBR	EPDM	NBR	FKM
26.9	Flex E 26.9	0582 9100 026	0582 8400 026	0582 9200 026	0582 8500 026	0582 9300 026	0582 8600 026	
28.0	Flex E 28.0	0582 9100 028	0582 8400 028	0582 9200 028	0582 8500 028	0582 9300 028	0582 8600 028	
30.0	Flex E 30.0	0582 9100 030	0582 8400 030	0582 9200 030	0582 8500 030	0582 9300 030	0582 8600 030	
33.7	Flex E 33.7	0582 9100 033	0582 8400 033	0582 9200 033	0582 8500 033	0582 9300 033	0582 8600 033	0582 9900 033
35.0	Flex E 35.0	0582 9100 035	0582 8400 035	0582 9200 035	0582 8500 035	0582 9300 035	0582 8600 035	
38.0	Flex E 38.0	0582 9100 038	0582 8400 038	0582 9200 038	0582 8500 038	0582 9300 038	0582 8600 038	0582 9900 038
42.4	Flex E 42.4	0582 9100 042	0582 8400 042	0582 9200 042	0582 8500 042	0582 9300 042	0582 8600 042	0582 9900 042
44.5	Flex E 44.5	0582 9100 044	0582 8400 044	0582 9200 044	0582 8500 044	0582 9300 044	0582 8600 044	
48.3	Flex E 48.3	0582 9100 048	0582 8400 048	0582 9200 048	0582 8500 048	0582 9300 048	0582 8600 048	0582 9900 048
54.0	Flex E 54.0	0582 9100 054	0582 8400 054	0582 9200 054	0582 8500 054	0582 9300 054	0582 8600 054	
57.0	Flex E 57.0	0582 9100 057	0582 8400 057	0582 9200 057	0582 8500 057	0582 9300 057	0582 8600 057	0582 9900 057
60.3	Flex E 60.3	0582 9100 060	0582 8400 060	0582 9200 060	0582 8500 060	0582 9300 060	0582 8600 060	0582 9900 060
63.0	FLEX E 63.0	0582 9100 063	0582 8400 063	0582 9200 063	0582 8500 063	0582 9300 063	0582 8600 063	0582 9900 063
70.0	Flex E 70.0	0582 9100 070	0582 8400 070	0582 9200 070	0582 8500 070	0582 9300 070	0582 8600 070	
73.0	Flex E 73.0	0582 9100 073	0582 8400 073	0582 9200 073	0582 8500 073	0582 9300 073	0582 8600 073	
76.1	Flex E 76.1	0582 9100 076	0582 8400 076	0582 9200 076	0582 8500 076	0582 9300 076	0582 8600 076	0582 9900 076
80.0	Flex E 80.0	0582 9100 080	0582 8400 080	0582 9200 080	0582 8500 080	0582 9300 080	0582 8600 080	
84.0	Flex E 84.0	0582 9100 084	0582 8400 084	0582 9200 084	0582 8500 084	0582 9300 084	0582 8600 084	
88.9	Flex E 88.9	0582 9100 088	0582 8400 088	0582 9200 088	0582 8500 088	0582 9300 088	0582 8600 088	0582 9900 088
101.6	Flex E 101.6	0582 9100 101	0582 8400 101	0582 9200 101	0582 8500 101	0582 9300 101	0582 8600 101	
104.0	Flex E 104.0	0582 9100 104	0582 8400 104	0582 9200 104	0582 8500 104	0582 9300 104	0582 8600 104	
108.0	Flex E 108.0	0582 9100 108	0582 8400 108	0582 9200 108	0582 8500 108	0582 9300 108	0582 8600 108	
110.0	Flex E 110.0	0582 9100 110	0582 8400 110	0582 9200 110	0582 8500 110	0582 9300 110	0582 8600 110	
114.3	Flex E 114.3	0582 9100 114	0582 8400 114	0582 9200 114	0582 8500 114	0582 9300 114	0582 8600 114	0582 9900 114
129.0	Flex E 129.0	0582 9100 129	0582 8400 129	0582 9200 129	0582 8500 129	0582 9300 129	0582 8600 129	0582 9900 129
133.0	Flex E 133.0	0582 9100 133	0582 8400 133	0582 9200 133	0582 8500 133	0582 9300 133	0582 8600 133	
139.7	Flex E 139.7	0582 9100 139	0582 8400 139	0582 9200 139	0582 8500 139	0582 9300 139	0582 8600 139	0582 9900 139
141.3	Flex E 141.3	0582 9100 141	0582 8400 141	0582 9200 141	0582 8500 141	0582 9300 141	0582 8600 141	
154.0	Flex E 154.0	0582 9100 154	0582 8400 154	0582 9200 154	0582 8500 154	0582 9300 154	0582 8600 154	
159.0	Flex E 159.0	0582 9100 159	0582 8400 159	0582 9200 159	0582 8500 159	0582 9300 159	0582 8600 159	
168.3	Flex E 168.3	0582 9100 168	0582 8400 168	0582 9200 168	0582 8500 168	0582 9300 168	0582 8600 168	0582 9900 168



NORMACONNECT® FLEX is an axial non-restraint coupling. It is used for connecting metal pipes, stainless pipes, as well as concrete and plastic pipes. This is a full trunnions version.

**Material**  
W2, W4, W5

NORMACONNECT®

NORMACONNECT® FGR FLEX											
Ø (O.D.)	Designation	Clamping ranges	PN <sup>1</sup> (MAWP <sup>1</sup> from Ø 180)	WP <sup>2</sup>	C max	Dimensions (approx.)			Weight (approx.)	Hex socket locking bolts	
		Odmin - Odmax (mm)	 [ bar]	 [bar]	(mm)	a (mm)	d (mm)	H (mm)	(kg/pc.)	Thread	Tightening torque (Nm)
180.0	Flex 180.0	178.0 - 182.0	16.0	50.0	35	141	210	240	5.4	M 12 SW 10	35
193.7	Flex 193.7	192.0 - 196.0	16.0	46.0	35	141	225	255	5.6	M 12 SW 10	35
206.0	Flex 206.0	202.0 - 208.0	16.0	43.0	35	141	240	270	5.8	M 12 SW 10	35
219.0	Flex 219.0	216.0 - 221.0	16.0	40.5	35	141	250	280	6.0	M 12 SW 10	35
225.0	Flex 225.0	222.0 - 227.0	16.0	40.0	35	141	255	285	6.1	M 12 SW 10	35
229.9	Flex 229.9	228.0 - 232.0	16.0	39.0	35	141	260	290	6.2	M 12 SW 10	35
244.5	Flex 244.5	242.0 - 247.0	16.0	37.0	35	141	275	305	6.4	M 12 SW 10	35
254.0	Flex 254.0	250.0 - 256.0	16.0	35.5	35	141	285	315	6.5	M 12 SW 10	35
267.0	Flex 267.0	264.0 - 269.0	16.0	33.5	35	141	300	330	6.7	M 12 SW 10	35
273.0	Flex 273.0	270.0 - 275.0	16.0	33.0	35	141	305	335	6.8	M 12 SW 10	35
306.0	Flex 306.0	302.0 - 308.0	15.0	29.0	35	141	340	370	7.4	M 12 SW 10	35
323.9	Flex 323.9	320.0 - 327.0	15.0	28.0	35	141	355	385	7.6	M 12 SW 10	35
326.0	Flex 326.0	322.0 - 329.0	13.0	27.5	35	141	360	390	7.7	M 12 SW 10	35
355.6	Flex 355.6	352.0 - 359.0	13.0	25.0	35	141	390	420	8.1	M 12 SW 10	35
406.4	Flex 406.4	402.0 - 410.0	10.0	22.0	35	141	440	470	8.9	M 12 SW 10	35
429.0	Flex 429.0	426.0 - 431.0	7.5	21.0	35	141	460	490	9.3	M 12 SW 10	40
442.0	Flex 442.0	439.0 - 444.0	7.5	20.0	35	141	475	505	9.5	M 12 SW 10	40
457.2	Flex 457.2	454.0 - 459.0	7.5	19.5	35	141	490	520	9.7	M 12 SW 10	40
508.0	Flex 508.0	505.0 - 510.0	7.5	17.0	35	141	540	570	10.5	M 12 SW 10	40
531.0	Flex 531.0	528.0 - 534.0	7.5	16.0	35	141	565	595	10.9	M 12 SW 10	50
558.8	Flex 558.8	556.0 - 562.0	7.5	15.5	35	141	590	620	11.3	M 12 SW 10	50
609.6	Flex 609.6	606.0 - 613.0	6.0	14.0	35	141	640	670	12.1	M 12 SW 10	50
634.0	Flex 634.0	631.0 - 637.0	5.0	13.5	35	141	665	695	12.5	M 12 SW 10	50
711.2	Flex 711.2	707.0 - 715.0	5.0	12.0	35	141	745	775	13.7	M 12 SW 10	50
762.0	Flex 762.0	758.0 - 766.0	4.5	11.0	35	141	795	885	14.5	M 12 SW 10	50
812.8	Flex 812.8	808.0 - 817.0	4.5	10.5	35	141	845	935	17.2	M 12 SW 10	50
914.4	Flex 914.4	909.0 - 919.0	3.3	9.5	35	141	945	1035	18.8	M 12 SW 10	60
1016.0	Flex 1016.0	1013.0 - 1019.0	3.3	8.0	35	141	1050	1140	20.4	M 12 SW 10	60
1117.5	Flex 1117.5	1114.0 - 1120.0	3.3	7.5	35	141	1150	1240	22.0	M 12 SW 10	60
1219.2	Flex 1219.2	1216.0 - 1222.0	3.3	7.0	35	141	1250	1340	23.6	M 12 SW 10	60

PN<sup>1</sup> (Nominal Pressure) is the max. admissible working pressure in shipbuilding, based on a safety factor of ≥ 4.  
MAWP<sup>1</sup> (Maximum Allowable Working Pressure) is the max. admissible working pressure in shipbuilding, based on a safety factor of ≥ 4.  
WP<sup>2</sup> is the max. working pressure in industrial applications, with a safety factor as per NORMA specification.

### Technical data & Ordering information

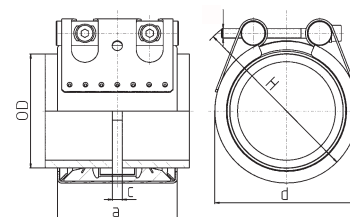

NORMACONNECT® FGR FLEX							
Ø (O.D.)	Designation	W2 Product No.		W4 Product No.		W5 Product No.	
		EPDM	NBR	EPDM	NBR	EPDM	NBR
180.0	Flex 180.0	0575 8140 180	0575 8440 180	0575 8240 180	0575 8540 180	0575 8340 180	0575 8640 180
193.7	Flex 193.7	0575 8140 193	0575 8440 193	0575 8240 193	0575 8540 193	0575 8340 193	0575 8640 193
206.0	Flex 206.0	0575 8140 206	0575 8440 206	0575 8240 206	0575 8540 206	0575 8340 206	0575 8640 206
219.0	Flex 219.0	0575 8140 219	0575 8440 219	0575 8240 219	0575 8540 219	0575 8340 219	0575 8640 219
225.0	Flex 225.0	0575 8140 225	0575 8440 225	0575 8240 225	0575 8540 225	0575 8340 225	0575 8640 225
229.9	Flex 229.9	0575 8140 229	0575 8440 229	0575 8240 229	0575 8540 229	0575 8340 229	0575 8640 229
244.5	Flex 244.5	0575 8140 244	0575 8440 244	0575 8240 244	0575 8540 244	0575 8340 244	0575 8640 244
254.0	Flex 254.0	0575 8140 254	0575 8440 254	0575 8240 254	0575 8540 254	0575 8340 254	0575 8640 254
267.0	Flex 267.0	0575 8140 267	0575 8440 267	0575 8240 267	0575 8540 267	0575 8340 267	0575 8640 267
273.0	Flex 273.0	0575 8140 273	0575 8440 273	0575 8240 273	0575 8540 273	0575 8340 273	0575 8640 273
306.0	Flex 306.0	0575 8140 306	0575 8440 306	0575 8240 306	0575 8540 306	0575 8340 306	0575 8640 306
323.9	Flex 323.9	0575 8140 323	0575 8440 323	0575 8240 323	0575 8540 323	0575 8340 323	0575 8640 323
326.0	Flex 326.0	0575 8140 326	0575 8440 326	0575 8240 326	0575 8540 326	0575 8340 326	0575 8640 326
355.6	Flex 355.6	0575 8140 355	0575 8440 355	0575 8240 355	0575 8540 355	0575 8340 355	0575 8640 355
406.4	Flex 406.4	0575 8140 406	0575 8440 406	0575 8240 406	0575 8540 406	0575 8340 406	0575 8640 406
429.0	Flex 429.0	0575 8140 429	0575 8440 429	0575 8240 429	0575 8540 429	0575 8340 429	0575 8640 429
442.0	Flex 442.0	0575 8140 442	0575 8440 442	0575 8240 442	0575 8540 442	0575 8340 442	0575 8640 442
457.2	Flex 457.2	0575 8140 457	0575 8440 457	0575 8240 457	0575 8540 457	0575 8340 457	0575 8640 457
508.0	Flex 508.0	0575 8140 508	0575 8440 508	0575 8240 508	0575 8540 508	0575 8340 508	0575 8640 508
531.0	Flex 531.0	0575 8140 531	0575 8440 531	0575 8240 531	0575 8540 531	0575 8340 531	0575 8640 531
558.8	Flex 558.8	0575 8140 558	0575 8440 558	0575 8240 558	0575 8540 558	0575 8340 558	0575 8640 558
609.6	Flex 609.6	0575 8140 609	0575 8440 609	0575 8240 609	0575 8540 609	0575 8340 609	0575 8640 609
634.0	Flex 634.0	0575 8140 634	0575 8440 634	0575 8240 634	0575 8540 634	0575 8340 634	0575 8640 634
711.2	Flex 711.2	0575 8140 711	0575 8440 711	0575 8240 711	0575 8540 711	0575 8340 711	0575 8640 711
762.0	Flex 762.0	0575 8140 762	0575 8440 762	0575 8240 762	0575 8540 762	0575 8340 762	0575 8640 762
812.8	Flex 812.8	0575 8140 812	0575 8440 812	0575 8240 812	0575 8540 812	0575 8340 812	0575 8640 812
914.4	Flex 914.4	0575 8140 914	0575 8440 914	0575 8240 914	0575 8540 914	0575 8340 914	0575 8640 914
1016.0	Flex 1016.0	0575 8141 016	0575 8441 016	0575 8241 016	0575 8541 016	0575 8341 016	0575 8641 016
1117.5	Flex 1117.5	0575 8141 117	0575 8441 117	0575 8241 117	0575 8541 117	0575 8341 117	0575 8641 117
1219.2	Flex 1219.2	0575 8141 219	0575 8441 219	0575 8241 219	0575 8541 219	0575 8341 219	0575 8641 219

NORMACONNECT®



info@iq-parts.nl  
Harsweg 34A  
2461 EZ Ter Aar  
T +31 252 624 126  
The Netherlands